

Serenata

Getting Started

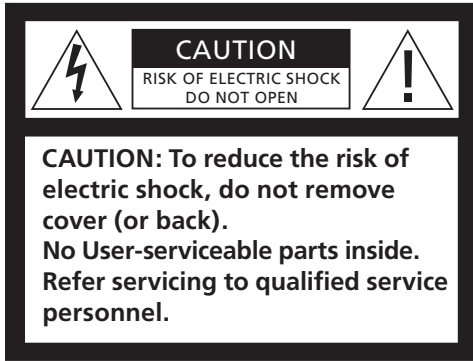

For important safety precautions and health and safety information, refer to the CD-rom Guide.

WARNING: To reduce the risk of fire or electric shock, do not expose this appliance to rain or moisture. Do not expose this equipment to dripping or splashing and ensure that no objects filled with liquids, such as vases, are placed on the equipment.

To completely disconnect this equipment from the AC Mains, disconnect the mains plug from the wall socket. The disconnect device shall remain readily operable.



The lightning flash with arrowhead symbol within an equilateral triangle, is intended to alert the user to the presence of un-insulated “dangerous voltage” within the product’s enclosure that may be of sufficient magnitude to constitute a risk of electric shock to persons.



The exclamation point within an equilateral triangle is intended to alert the user to the presence of important operating and maintenance (servicing) instructions in the literature accompanying the product.

Serenata **– a music mobile phone**

The Serenata music mobile phone combines a portable music system with the convenience of customised mobile phone communications.

The music and phone features can be used both separately and in combination.

For example, you can write an SMS while you listen to music at the same time. Or you can block incoming calls and messages, if you wish to purely listen to music for a while.

About this Guide

This Guide describes the basic principles of how to use your Serenata music phone.

A more detailed description of the features and functions of the phone can be found in the CD-rom Guide enclosed with this product.

For more help

As an additional help to the Guides you may also:

... visit our website to see answers to the most frequently asked questions about the phone.

... visit your local Bang & Olufsen retailer for advice.

... contact Bang & Olufsen's international Customer Service that offers support by email or telephone in six languages.

Call +45 9684 4525 or email via www.bang-olufsen.com



For an extended description of features and functions, insert the disc in a CD-rom drive and follow the instructions on the screen.

Before you start, 6

Find out how to insert SIM-card and battery, and charge the phone the first time you use it.

Options to use the phone, 7

Find out which options you have when you talk on the phone and when you listen to music.

Introducing the phone, 8

Find out how to operate the wheel and display to use the main functions of your music phone.

Display operation, 10

How to operate the main display functions of the Serenata music phone.

Daily use of the phone, 12

Find out how to use the basic phone options to make calls, create messages, add contacts to the phonebook and browse the web.

Play music, 16

How to transfer music from the computer to your phone and how to operate the music player.

Cable connections, 18

Find out how to charge the phone and connect it to the enclosed cables and earset.

Synchronise with Outlook, 20

Find out how to transfer contacts and calendar entries from Outlook to the phone.

International guarantee, 21

Read the conditions of the Bang & Olufsen product guarantee.

Before you start

Before you start using the phone, you must insert the enclosed battery and the SIM-card that you wish to use, then charge the phone.

To insert SIM-card and battery ...

- 1 Slide the backside upwards to raise the loudspeaker. Pull out the phone's stand.
- 2 Lift the battery cover away.
- 3 Insert the SIM-card.
Note! Make sure that the gold-coloured contacts on the card face downwards.
- 4 Insert the battery.
- 5 Slide the cover back on and press lightly.
- 6 Plug the charger into the phone, and connect it to the mains.

Note: For further information about charging, refer to page 18.

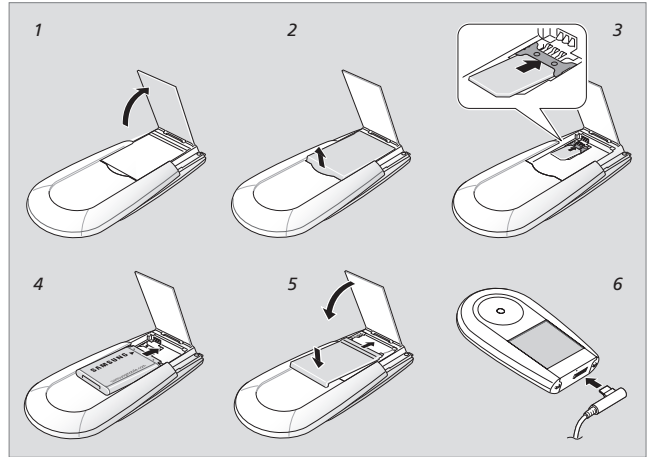

Ready for use

It takes approximately three hours to charge the phone. When the phone is charged, unplug the charger, and the phone is ready for use. To switch on the phone, press and hold the red button on the wheel.

Enter PIN-code

When you switch on the phone the first time, you may have to enter the pincode of your SIM-card. Use the wheel to highlight digits and press the **OK** button at the centre of the wheel to select. Then highlight ✓ and press **OK**.

Your phone consists of two equal parts; a portable audio system and a mobile phone. Whether you use phone functions or wish to listen to music, you have several options.

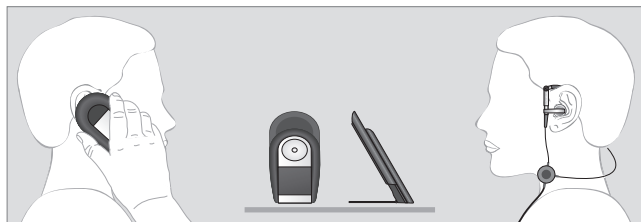

Options to use the phone

When you use the phone functions you may ...

- Use the phone by holding it to your ear.
- Use the enclosed earset to talk on the phone.
- Use the phone's loudspeaker to talk hands-free. Simply raise the loudspeaker and pull out the phone's stand, then place it in front of you, for example, on a table.

Options to listen to music

When you use the music functions you may ...

- Use the enclosed earset as a headset to listen to music in your private sphere.
- Raise the built-in loudspeaker, which allows you to use the phone as a micro audio system.
- Connect playback music from the phone via the enclosed line output to your Bang & Olufsen music system setup.

Introducing your phone ...

The Serenata music phone is based on an intuitive user interface that combines simple one-hand operation through the wheel and the display with a colour code system that helps you navigate in the menus:

Blue signifies phone related functions ...

Red signifies music related functions ...

The key functions of the music phone are shown to the right.

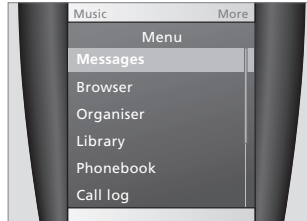

Blue menus represent phone related functions such as Messages, Browser and Organiser.

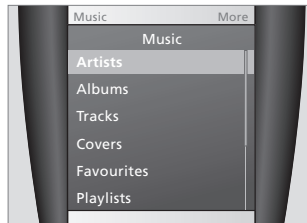

Red menus relate to the music functions, for example, Artists, Albums and Tracks. To operate the music phone, you must use both the wheel and the display.



Hold the phone as shown and use your thumb to turn the wheel and operate the buttons on the wheel and display.

You may also operate the phone while it stands on the table. This is relevant if, for example, you talk while you use the speaker phone.

1 – OK

Wake up the phone, when it is in sleep mode.

In idle mode, access the menu.

Select a highlighted menu option or confirm input.

2 – SEND (● green button)

Make or answer a call.

In idle mode, retrieve the numbers of recently dialled, missed or received calls.

Start playback of music.

Play/pause the music player.

3 – BACK ↶

Back up through menus.

In idle mode, press and hold to lock the phone.

4 – Music

Press the screen lightly to open the music player.

Switch between the phone and the music player.

5 – C

Delete characters from the display.

Press and hold to switch 'Silent mode' on and off.

6 – END (● red button)

Press and hold to switch the phone on and off.

End or reject a call.

End the music player.

In menu mode, press to return the phone to idle mode.

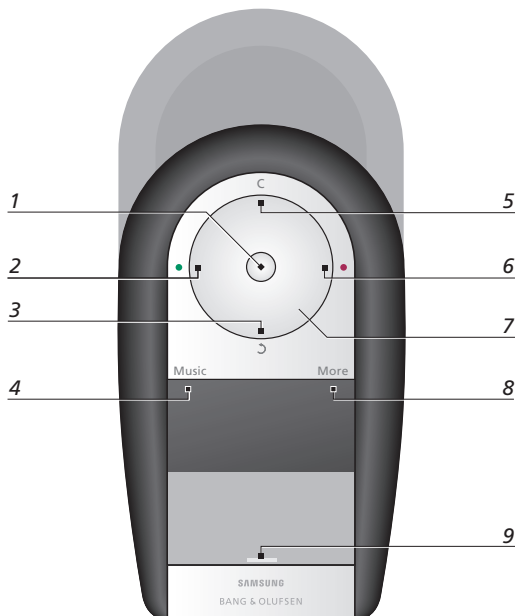
**7 – Wheel**

Turn the wheel to increase or lower volume.

In menu mode, scroll through menu options.

In idle mode, turn the wheel to search for a phonebook entry.

In sleep mode, wake up the phone with any button on the wheel.

8 – More

Press the screen lightly to access the **More** menu.

9 – Shortcuts

Press the lower part of the display to access shortcut buttons that you can customise.

Display operation

The display is divided into three main touch areas. In the centre of the screen is the invisible touch button, which opens to the dialling screen. In the upper corners of the screen are 'Music' and 'More'. And when you press the bar key at the bottom of the display, you bring up three shortcut buttons which can be customised according to your preferences.

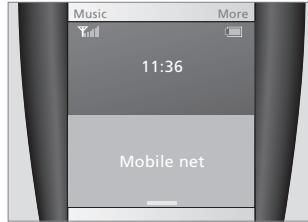

Wake up the phone ...

When not in use, the phone's display goes into sleep mode. To wake up the display and be able to operate the phone, press **OK** or any button on the wheel.

The illustration shows the phone in idle mode – ready to operate.

Useful hint ...

To lock or unlock the phone, press and hold **↻**.



Make a call ...

When the phone is in idle mode, just touch the centre of the display and the dialling screen appears.

Use the physical wheel to highlight digits and press **OK** to select. Then press the green **SEND** button to make the call.

Useful hint ...

When you have dialled a number once, you can add it to the phone-book.

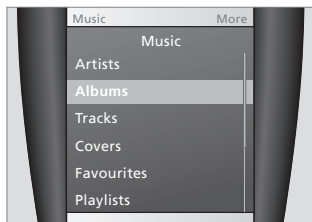

Use the Music menu ...

Touch the upper left corner of the screen to bring up the **Music** menu. Use the wheel to scroll down to highlight, for example, *Albums* from the list and press **OK** to select. Then use the wheel to choose between available albums, and press **SEND** to playback the album you wish to listen to.

Useful hint ...

While you play music, you can bring up the **More** menu, for example, to pause the music or add the album to your favourites.

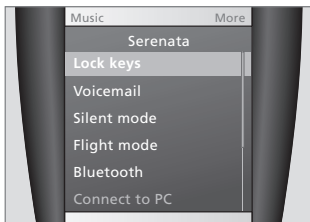

Use the More menus ...

Touch the upper right corner of the screen to bring up a **More** menu. **More** menus are context specific, as they contain additional functions related to the feature you use.

They can be brought up whether you use a phone or music function; for example to *Add to playlist*, when you use the music player or *Hold* when you use the phone.

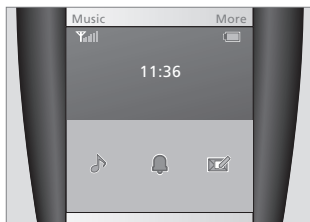

Use the shortcuts ...

The display has three shortcut buttons which can be accessed directly via the bar key at the bottom of the display in idle mode. The shortcuts can be customised to give quick access to specific functions that you use frequently.

You can select among 25 different features such as *PureMusic*, *Alarm* and *Create Message*, as shown in the illustration above.

Daily use of the phone

The main menu allows you to access the basic functions of your music phone such as Messages, Organiser and Phonebook.

The phonebook has room for 1,000 contacts that you can write to via SMS, MMS or email – all while you listen to your favourite music.

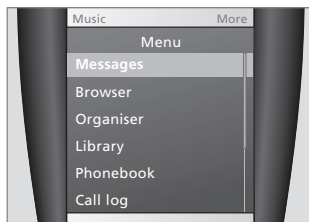

Access options ...

In idle mode, press **OK** to access Menu mode and view the main features of the phone.

In Menu mode, simply turn the wheel to highlight the function you wish to use, then press **OK** to select.

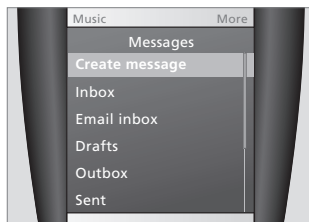

Create a message ...

To create a message, select *Messages*, then *Create Message* and choose between *SMS*, *MMS* and *Email*.

Use the wheel to highlight, for example, *Text message* and press **OK** to select. Then enter your message and press *Send* in the lower right corner of the display to send the message.



How to enter text ...

You must enter text, for example, when you write a text message or wish to add a new contact to the phonebook.

In text mode, use the wheel to highlight letters and press **OK** once to select the first letter, twice to select the second, and so on.

Useful hint ...

When you purchase the phone it is set to **ABC** mode. To switch between **ABC** and **T9** mode, press and hold ↵ at the bottom of the screen.



Enter special characters ...

To insert numbers or symbols into the text, press **&:@** in the lower left corner; once for symbols, and twice for numbers.

To switch between upper and lower case characters, just press ↵ on the touch screen.

Useful hint ...

When you enter text, you can use the green **SEND** button to insert a space. To delete characters, use **C** on the wheel.

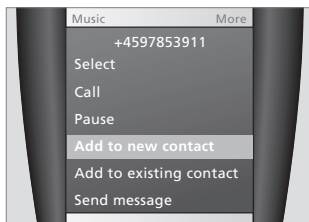

Add contacts to Phonebook ...

Before you send, for example, a text message, you can add the contact to your phonebook:

- > In idle mode, touch the centre of the display to open the dialling screen.
- > Enter a phone number.
- > Press **More** and select *Add to new contact*.
- > Specify name and other contact information such as email address or birthday, if necessary.
- > Then press **More** to save the contact.

How to make a call ...

- > In idle mode, press the centre of the display to open the dialling screen.
- > Enter the number and press **SEND** to make the call.
- > To end the call, press **END**.

When you dial ...

- > Press **C** to clear the last digit.
- > Press and hold **C** to clear the whole display.
- > Press the centre of the display to enter cursor mode.

How to answer a call ...

- > In idle mode, press **SEND** to answer a call.

Useful hint ...

To mute the phone during an incoming call, turn the wheel counter-clockwise.

Redial recent numbers ...

- > In idle mode, press **SEND** to display the list of recent numbers.
- > Scroll to the number you want and press **SEND** to make the call.

Make calls from the phonebook

For quick access to the phonebook:

- > Turn the wheel clockwise or counter-clockwise, when in idle mode.
- > Select the first character of the contact you wish to find and scroll to the name.
- > Then press the **SEND** button to make the call.

Useful hint ...

To adjust the volume during a call, simply turn the wheel.

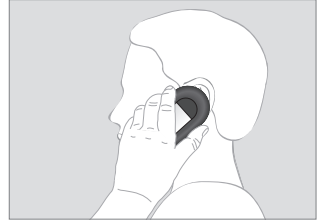
**Options during a call**

During a call, you can press **OK** followed by **More** to:

- Access the phonebook to view contact details
- Send a text message to the person on the phone, or
- Make a second call while you talk on the phone.

Useful hint ...

We recommend that you hold the phone in your hand while you use these options – simply raise the loudspeaker or use the enclosed earset to do so.

Your music phone allows you to get easy access to the Internet and makes it possible to send and read emails wherever you are.

Note: The phone must be set up to browse the web and send emails. For further information, refer to the CD-rom Guide or contact your Bang & Olufsen retailer.

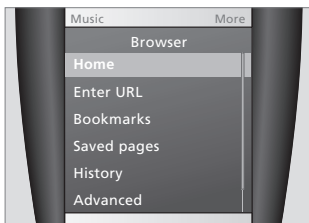

Browse the web ...

To enter the Browser menu:

- > Press **OK** in idle mode and select *Browser*.
- > Then select one of the options available, for example; *Home*, *Enter URL* or *Saved pages*.

To navigate on the web ...

- > Use the wheel to select a browser item, then press **OK** and choose **Select**.
- > Press **Back** to step to the previous page.
- > Press **More** to access additional browser options.

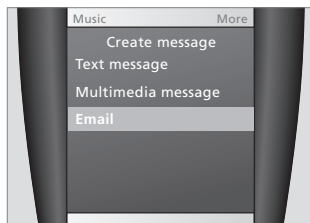

To send an email ...

- > Press **OK** in idle mode and select *Messages >Create Message >Email*.
- > Enter text as described on page 13 in this Guide.
- > Then press the *Send* button in the bottom of the display.
- > Press **More** to access additional email options.

Play music

The music phone allows you to listen to your favourite music wherever you are – and it is easy to transfer your digital music from the computer to your phone.

You can use BeoPlayer or Windows MediaPlayer (*version 11 or higher*) to transfer digital music from your computer to the music phone.

To transfer music to the phone ...

- > Connect the phone to the PC via the USB cable. Or place the phone in the charger and connect the USB cable to the charger.
- > Press **More**.
- > Select *Connect to PC*.*
- > Then select *MTP*.

Note: If you use a MAC, select *Mass storage*.

MTP (Media Transfer Protocol) allows you to use BeoPlayer or Windows MediaPlayer® to store music on the phone.

Useful hint ...

If you wish to transfer music covers to the phone, you must use the MTP transfer mode.

*If *Connect to PC* does not appear in the **More** menu:

- > In idle mode, press **OK** to bring up the Menu.
- > Select *Settings*.
- > Press *Phone settings*.
- > Press *Transfer mode*, and choose *Manual*.

About BeoPlayer

The Bang & Olufsen BeoPlayer software and further guidance are included on the enclosed CD-rom. BeoPlayer automatically sorts your music alphabetically by genre, artist, track title and album title and allows you to make your own playlists.

You can download your tracks directly from the Internet, or use BeoPlayer to record them from a CD and store them on your PC.

For further information about BeoPlayer and how to transfer music, refer to the CD-rom Guide enclosed with this product.

Warning for MAC users! To prevent damage to your phone during transfer of music, always select *'Eject Serenata'* on the computer, before you disconnect the phone from your computer.

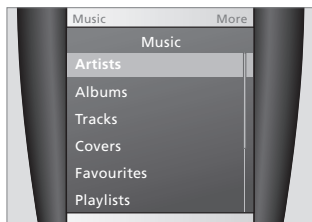

How to play music ...

Press **Music** to open the music player:

- > In the Music menu, use the wheel to highlight a music view, for example, *Artists*, and press **OK** to select.
- > In *Artists* view, use the wheel to highlight the initial of a specific artist, and press **OK** to select.
- > Then press **SEND** to playback the album(s) available by this artist.
- > If you wish to select a specific album or track, press **OK** to step down through levels, and press **SEND** to start playback.

OK = To select options and step down through levels.

SEND = To start random playback at any level of a view.

Useful hint ...

For automatic playback of the last played music, press **Music** and wait a few seconds.

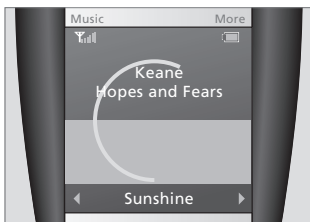

To operate the music player ...

During playback, use the following buttons for basic operation:

- > Turn the wheel to adjust the volume.
- > To step through tracks or albums, press the lower part of the screen, then use the arrows to navigate, as shown.
- > Press **SEND** to pause or resume playback.
- > Press **END** to stop playback and close the music player.

Note that you can only operate the music player, when in *Now playing* mode. To return to *Now playing*, just press the centre of the display.

Useful hint ...

To toggle between the music player and the phone during playback, simply press **Music**.

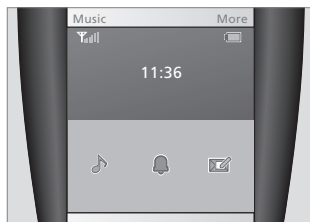

Relax with PureMusic ...

If you wish to listen to music without disturbance from incoming calls or messages:

- > In idle mode, press **the bar** in the bottom of the display to bring up the three shortcut buttons.
- > Press  to activate PureMusic.

The phone will then direct all calls to the voicemail.

Play music when you fly ...

You can activate the *Flight mode* option in the **More** menu, whenever you need to disable the phone, but still wish to enjoy the music – for example on a flight.

Useful hint ...

To access additional options while you play music, you can bring up the **More** menu.

Cable connections

To charge the phone, connect the table charger to the mains supply and place the phone in the charger.

The table charger allows you to connect the phone to your computer via the USB socket.

If you wish to use the phone, while it is still in the charger, you may also connect the enclosed earset.

You can also use the enclosed travel charger to charge the phone – just connect it directly to the phone.

About charging

It takes approximately three hours to fully charge the phone. When fully charged, the phone will have enough capacity to power:

- Up to three hours talk-time.
- Up to 11 days in standby.

During offline playback ...

- Up to five hours when you use the loudspeaker.
- Up to 13 hours when you use the headset.

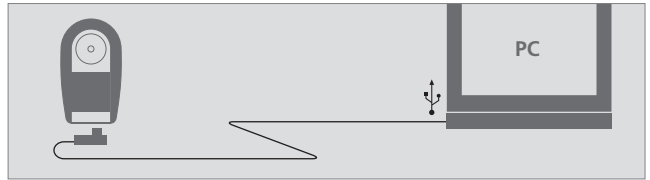
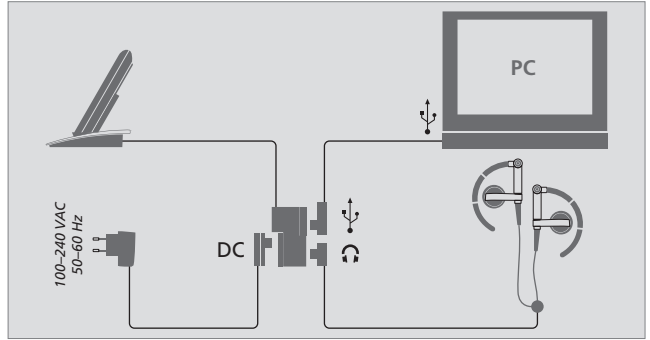

When the battery is low:

- A warning tone sounds.
- The 'Battery low' message displays.
- The empty battery icon (☐) blinks.

Useful hint ...

It is also possible to connect the phone to your Bang & Olufsen audio system setup. Use the enclosed line output to do so.

NOTE! We recommend that your computer has a mains supply, which is connected to ground.

Wear and use EarSet 3

For maximum sound quality, we recommend that you assemble, place and adjust the enclosed earset as shown on this page.

WARNING! Prolonged use at high volume may cause hearing damage!

To use the earset ...

First place the left earphone. Then lead the cord behind your neck, and adjust the right earphone to your ear.

To operate the earset ...

- > Press the centre of the microphone (A) to answer a call.
- > Press again to end the call.
- > Press and hold to redial the last called number.

To hold the microphone cord in place, use the enclosed clip (B).

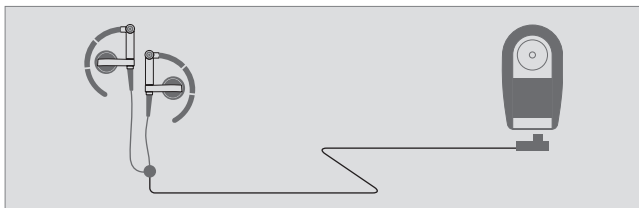
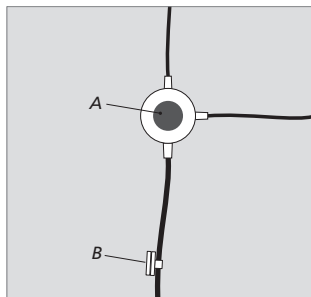
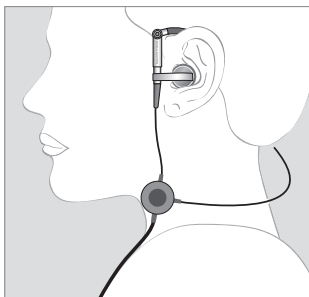
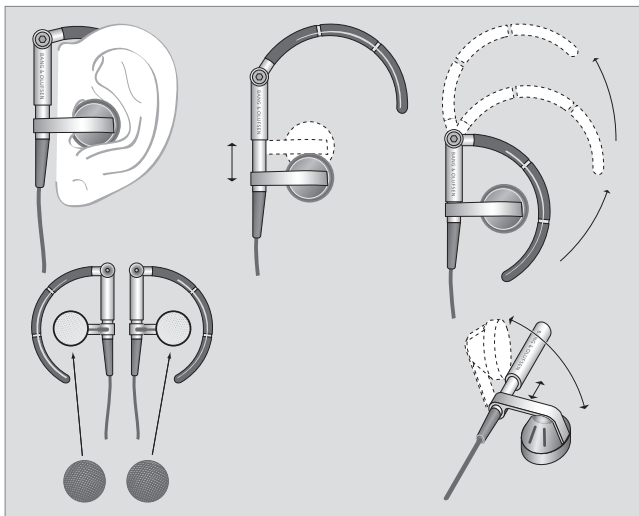

Synchronise the phonebook with Outlook

It is possible to synchronise your phone with Outlook®, if you wish to transfer, for example, contacts or calendar entries to the phone.

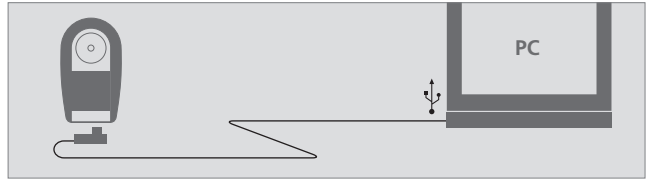

The phone can synchronise with Outlook either via the USB-cable or via BlueTooth®:

- > Connect the phone to your computer or to BlueTooth.
- > Select *Transfer*.
- > Select *PC Studio*.
- > Then start *Samsung PC Studio* on the computer and select *Synchronise*.

For further information, refer to the extended CD-rom Guide enclosed with this product.

Each Bang & Olufsen product purchased from an authorised Bang & Olufsen retailer carries a guarantee against defects in workmanship and materials.

The guarantor is the authorised Bang & Olufsen retailer or subsequently the national Bang & Olufsen representative. The guarantee period is 24 months, unless otherwise specified in the country of purchase.

The guarantee covers repair costs (i.e. spare parts and labour costs) for the product. The guarantee also covers accessories. There is a 24-month right of claim on replaced and repaired parts.

The guarantee applies worldwide. It will be met by all authorised Bang & Olufsen retailers.

The guarantee does not cover damage due to accidents, including damage by lightning, water, fire, transport, misuse or negligence.

Bang & Olufsen is not liable for any indirect loss or any consequential loss.

The guarantee does not cover rental of replacement products and costs of modifications required to adapt the product to different voltage or broadcasting standards. The replacement of e.g. batteries is not covered by the guarantee.

The guarantee is void if the product is repaired or modified by anyone other than a person authorised by Bang & Olufsen, or if the serial number has been removed from the product.

If you intend to use your audio/video product in another country, we recommend that you obtain information from your retailer on voltage and radio and television standards in the country you intend to move to. The retailer will advise you of possible modifications.

In Japan, North America, South America, Taiwan and South Korea it is not possible to have repairs or modifications made to television sets or video recorders which have not been produced specifically for use in these countries.

For the guarantee to be valid a document is normally required stating the following:

- Name of product and type number
- Serial number
- Date of purchase/delivery
- Guarantee period
- Stamp and signature of authorised Bang & Olufsen retailer.



Waste Electrical and Electronic Equipment (WEEE) – Environmental protection

The European Parliament and the Council of the European Union have issued the Waste Electrical and Electronic Equipment Directive. The purpose of the Directive is the prevention of waste of electrical and electronic equipment, and to promote the reuse and recycling and other forms of recovery of such waste. As such the Directive concerns producers, distributors and consumers.

The WEEE directive requires that both manufacturers and end-consumers dispose of electrical and electronic equipment and parts in an environmentally safe manner, and that equipment and waste are reused or recovered for their materials or energy.

Electrical and electronic equipment and parts must not be disposed of with ordinary household refuse; all electrical and electronic equipment and parts must be collected and disposed of separately.

Products and equipment which must be collected for reuse, recycling and other forms of recovery are marked with the pictogram shown.

When disposing of electrical and electronic equipment by use of the collection systems available in your country, you protect the environment, human health and contribute to the prudent and rational use of natural resources. Collecting electrical and electronic equipment and waste prevents the potential contamination of nature with the hazardous substances which may be present in electrical and electronic products and equipment.

Your Bang & Olufsen retailer will assist with and advise you of the correct way of disposal in your country.

CE This product is in conformity with the provisions of the Directives 1999/5/EC and 2006/95/EC.

Technical specifications, features and the use thereof are subject to change without notice!

For the US-market only!

NOTE: This equipment has been tested and found to comply with the limits for a class B digital device, pursuant to part 15 of the FCC Rules. These limits are designed to provide reasonable protection against harmful interference in a residential installation.

This equipment generates, uses and can radiate radio frequency energy and, if not installed and used in accordance with the instructions, may cause harmful interference to radio communications. However, there is no guarantee that interference will not occur in a particular installation. If this equipment does cause harmful interference to radio or television reception, which can be determined by turning the equipment off and on, the user is encouraged to try to correct the interference by one or more of the following measures:

- Reorient or relocate the receiving antenna.
- Increase the separation between the equipment and receiver.
- Connect the equipment into an outlet on a circuit different from that to which the receiver is connected.
- Consult the retailer or an experienced radio/TV technician for help.

For the Canadian market only!

This class B digital apparatus meets all requirements of the Canadian Interference-Causing Equipment Regulations.



350952207080009